

# MINIATURE PRESSURE REGULATOR



	DESCRIPTION	PRESSURE RANGE		CONNECTION	SERIES	PAGE
			bar	thread		
<b>FACTORY-SET OUTLET PRESSURE</b>	Cartridge regulator		2 / 3 / 4 / 6	Cartridge	233	<b>1.02</b>
	without exhaust	17 x 25	2 / 3 / ... / 10	G $\frac{1}{4}$ ia	R13	<b>1.03</b>
	for liquids	34 x 52	1 / 2 / ... / 8	G $\frac{1}{4}$	239A	<b>1.04</b>
	for oxygen	34 x 52	1 / 2 / ... / 8	G $\frac{1}{4}$	239M	<b>1.04</b>
	for compressed air	34 x 52	1 / 2 / ... / 8	G $\frac{1}{4}$	231	<b>1.05</b>
	relieving		2 / 3 / ... / 8	G $\frac{1}{4}$ - G $\frac{3}{4}$	232	<b>1.06</b>
<b>SLIM DESIGN</b>	extremely small	19 x 40	0.2 ... 2 / 8	M5	RR-M5	<b>1.07</b>
	also with FKM and EPDM	18 x 65	0.2 ... 1.4 / 7	M5 / $\frac{1}{8}$ "NPT	MAR	<b>1.08</b>
<b>VERY ACCURATE</b>	very lightweight		0.03 ... 0.24 / 6	$\frac{1}{8}$ "NPT	R800	<b>1.09</b>
	very lightweight		0.03 ... 0.24 / 6	10-32" and flange	R900	<b>1.09</b>
	slim design		0 ... 0.35 / 7	M5 and flange	RT	<b>1.10</b>
	plastic		0.1 ... 1 / 12	G $\frac{1}{8}$ and G $\frac{1}{4}$	R039-F	<b>1.11</b>
	modular		0.01 ... 0.7 / 7	flange	R6	<b>1.12</b>
	interlockable		0.01 ... 0.7 / 7	M5, G $\frac{1}{8}$ , G $\frac{1}{4}$ , SS	R7	<b>1.13</b>
	inlet pressure compensated		0.2 ... 2 / 9	flange	R342	<b>1.14</b>
	without constant bleed		0.2 ... 2 / 9	G $\frac{1}{8}$ and G $\frac{1}{4}$	R344	<b>1.14</b>
	inlet pressure compensated		0.1 ... 3 / 6	G $\frac{1}{8}$	R309	<b>1.16</b>
	up to 25 bar supply pressure		0.1 ... 3 / 16	G $\frac{1}{8}$ and G $\frac{1}{4}$	R310	<b>1.16</b>
	FDA approved		0.1 ... 1 / 12	G $\frac{1}{8}$ and G $\frac{1}{4}$	R037	<b>1.17</b>
	very accurate		0.05 ... 2 / 8	G $\frac{1}{8}$	RI	5.02
	very accurate		0.05 ... 2 / 8	G $\frac{1}{8}$ and flange	R90	5.03
	<b>STANDARD</b>	increased accuracy		0.1 ... 1 / 12	G $\frac{1}{8}$ and G $\frac{1}{4}$	R039
also for water,		brass	0.1 ... 1 / 11	G $\frac{1}{8}$ and G $\frac{1}{4}$	R364	<b>1.15</b>
made of aluminium			0.1 ... 1 / 11	G $\frac{1}{8}$ and G $\frac{1}{4}$	R374	<b>1.15</b>
even for oxygen			0.2 ... 2.5 / 8	G $\frac{1}{8}$	R307	<b>1.18</b>
even for oxygen			0 ... 0.25 / 8	flange	R308	<b>1.19</b>
<b>CARTRIDGE</b>	up to 260 l/min		1 ... 8	G $\frac{1}{8}$ u. G $\frac{1}{4}$	RC	<b>1.20</b>



# 1

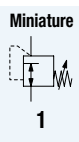

<b>Description</b>	Cartridge pressure regulator suitable for assembly block.		
<b>Media</b>	compressed air or non-corrosive gases		
<b>Supply pressure</b>	max. 12 bar		
<b>Adjustment</b>	Select the pressure regulator according to the desired outlet pressure. The outlet pressure cannot be subsequently adjusted. This safeguards against tampering.		
<b>Relieving function</b>	non-relieving		
<b>Temperature range</b>	-20 °C to 60 °C / -4 °F to 140 °F		
<b>Material</b>	Body: brass Elastomer: NBR	Piston: brass Filter: stainless steel	

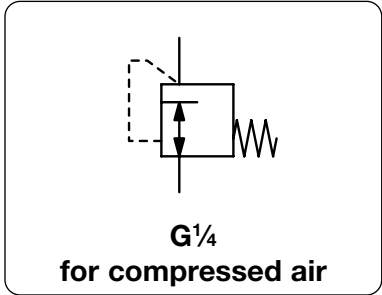

Dimensions		Flow rate	Supply pressure	Connection thread	Outlet pressure	Order number
A	A/F					
mm	mm	l/min*1	max. bar	G	bar*2	

Factory-set outlet pressure					P <sub>i</sub> : max. 12 bar, non-relieving, outlet pressure accuracy *2	233
24	14	350	12	G $\frac{1}{4}$ a	2	233G0220
					3	233G0230
					4	233G0240
					6	233G0260



233

### Special options, add the appropriate letter

<b>NPT</b>	connection thread	233GX2.0
------------	-------------------	----------

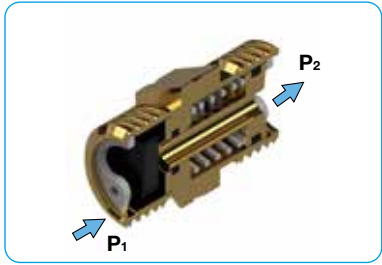

cross section

### Accessories, enclosed

<b>Adapter G<math>\frac{1}{4}</math></b>	263F0221
--	----------



233 incl. adapter

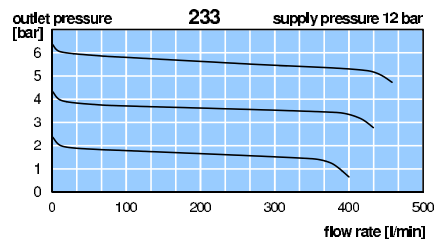
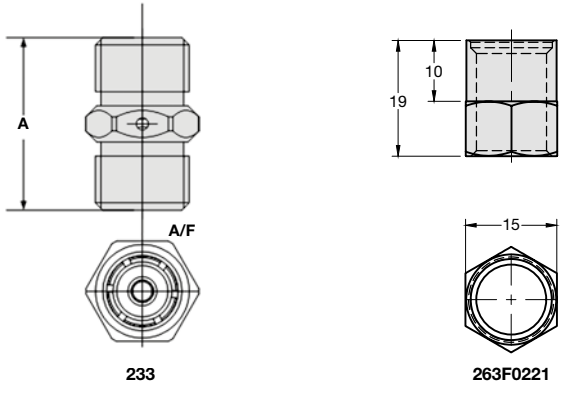

\*1 P<sub>e</sub> = 12 bar; Δp = 0.5 bar  
 \*2 Tolerance: 2 bar ± 0,6 bar (air, P<sub>e</sub> = 6 bar, 10 NI/min)  
 4 bar ± 0,8 bar (air, P<sub>e</sub> = 6 bar, 10 NI/min)  
 6 bar ± 1,0 bar (air, P<sub>e</sub> = 10 bar, 10 NI/min)

# IN-LINE REGULATOR WITH FACTORY-SET OUTLET PRESSURE

R13

**Description** In-Line pressure regulator with factory-set outlet pressure, reducing from e.g. 10 bar to 5 bar. The regulator R13 is suited for basic pressure control only with an outlet pressure tolerance of  $\pm 30\%$ . The outlet pressure stated below is valid for 12 bar inlet pressure. For other inlet pressure please refer to the according item from the diagram.

**Benefits**

- Higher safety through lower pressure. Tools and equipment protected against pressure damages.
- Cost reduction through substantially reduced air consumption. Longer service life.
- Noise reduction for tools.

**Media** compressed air or non-corrosive gases

**Supply pressure** max. 15 bar

**Adjustment** Select the pressure regulator according to the desired outlet pressure. The outlet pressure cannot be subsequently adjusted. This safeguards against tampering.

**Relieving function** non-relieving, therefore not recommended for applications such as nailers

**Temperature range** 0 °C to 60 °C / 32 °F to 140 °F, for appropriately conditioned compressed air down to -30 °C / -22 °F

**Material**  
 Body: brass  
 Elastomer: NBR/Buna-N, optionally FKM

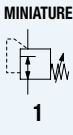
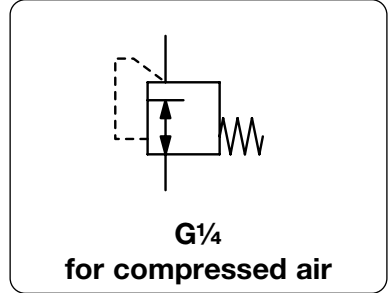

Dimensions			Flow rate	Supply pressure	Connection thread	Outlet pressure	Order number
ØA	B	A/F	l/min*1	max. bar	G	bar	
mm	mm	mm					

Basic accuracy regulator			P: max. 15 bar, non-relieving, outlet pressure accuracy $\pm 30\%$ , made of brass		R13		
17	34	17	300	15	G¼ia	2	R13-02D
						3	R13-02E
						4	R13-02F
						5	R13-02G
						6	R13-02H
						7	R13-02I
						8	R13-02K
						10	R13-02M



R13

## Special options, add the appropriate letter

**FKM elastomer for oxygen** specially cleaned, with oxygen grease not combineable with FKM elastomer

R13-02 . V  
R13-02 . 15



R13

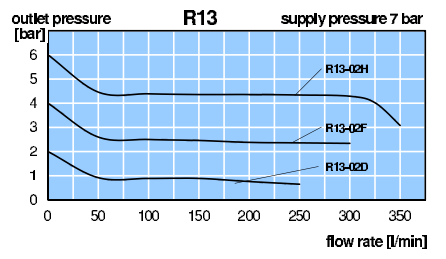
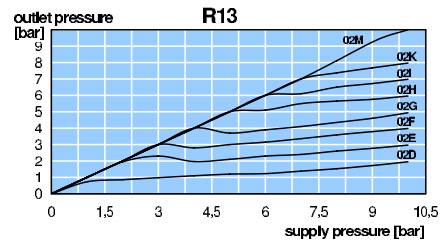
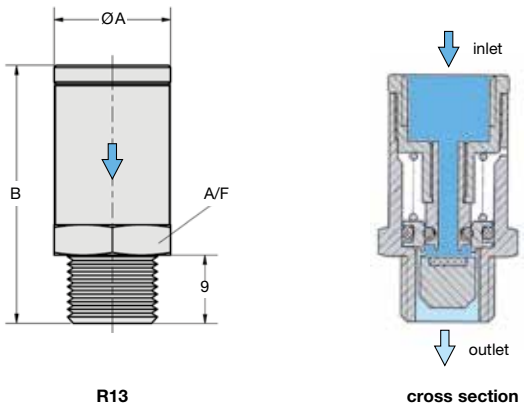

\*1 at 7 bar supply pressure, 6 bar outlet pressure and 2 bar pressure drop

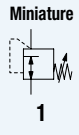

<b>General information</b>	In-Line pressure regulator with factory-set outlet pressure, reducing from e.g. 10 bar to 5 bar. The regulator is suited for basic pressure control only with an outlet pressure tolerance of approx. $\pm 10\%^{*2}$ . The outlet pressure cannot be subsequently adjusted. This safeguards against tampering.
<b>Description</b>	239A: regulator for liquids, compressed air and non-corrosive gases 239M: medical industry and pharmaceuticals
<b>Application</b>	water, hydraulic and sprinkler systems, cooler, cleaning systems
<b>Supply pressure</b>	max. 10 bar for liquids or oxygen max. 18 bar for compressed air and non-corrosive gases
<b>Temperature range</b>	0 °C to 60 °C / 32 °F to 140 °F
<b>Material</b>	Body: nickel-plated brass Inner parts: brass Elastomer: NBR/Buna-N for 239A, FKM for 239M

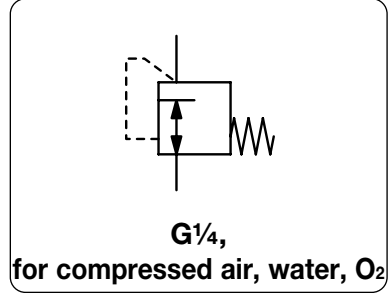

Dimensions			Flow rate		Supply pressure	Connection thread	Outlet pressure	Order number
Ø A	B	A/F	water	air	max. bar	G	bar <sup>*2</sup>	
mm	mm	mm	l/min <sup>*1</sup>					

Regulator for compr. air / water								made of brass, P <sub>1</sub> : max. 18 bar / 10 bar, NBR/Buna-N, outlet pressure accuracy <sup>*2</sup>	239A
34	52	17	10	400	18/10	G <sup>1</sup> / <sub>4</sub>	1		239A0210
			10	600			2		239A0220
			10	700			3		239A0230
			10	700			4		239A0240
			10	700			5		239A0250
			10	800			6		239A0260
			10	800			7		239A0270
			10	800			8		239A0280



239A / 239M

Regulator for oxygen								made of brass, P <sub>1</sub> : max. 10 bar, FKM, outlet pressure accuracy <sup>*2</sup>	239M
34	52	17	-	400	10	G <sup>1</sup> / <sub>4</sub>	1		239M0210
			-	600			2		239M0220
			-	700			3		239M0230
			-	700			4		239M0240
			-	700			5		239M0250
			-	800			6		239M0260
			-	800			7		239M0270
			-	800			8		239M0280

**Special options,** add the appropriate letter

**NPT** connection thread 239A1 . . .

**deviant pressure range** indicate on order 239 . . . 2XX

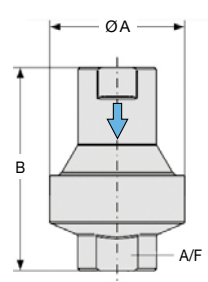

239A / 239M

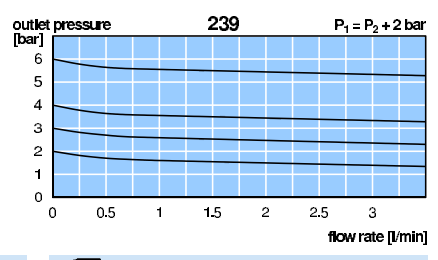
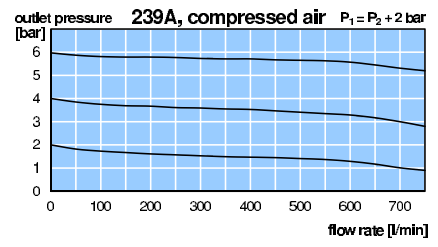
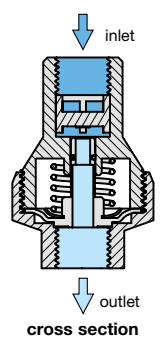

<sup>\*1</sup> P<sub>1</sub> = 10 bar; Δp = 0.8 bar

<sup>\*2</sup> Tolerance: < 4 bar ± 0.3 bar (air, P<sub>e</sub> = 6 bar, 10 NI/min)  
≥ 4 bar ± 10% (air, P<sub>e</sub> = 10 bar, 10 NI/min)

PDF CAD  
www.aircom.net

Order example:  
239A0210

<b>Description</b>	In-Line pressure regulator with factory-set outlet pressure, reducing from e.g. 15 bar to 5 bar. The regulator is suited for basic pressure control only with an outlet pressure tolerance of approx. $\pm 10\%$ <sup>2</sup> . Non-relieving function, therefore not recommended for applications such as nailers
<b>Benefits</b>	<ul style="list-style-type: none"> <li>• Higher safety through lower pressure. Tools and equipment protected against pressure damages</li> <li>• Cost reduction through substantially reduced air consumption</li> <li>• Noise reducing for tools</li> </ul>
<b>Media</b>	compressed air, non-corrosive gases
<b>Supply pressure</b>	max. 18 bar
<b>Adjustment</b>	Select the pressure regulator according to the desired outlet pressure. The outlet pressure cannot be subsequently adjusted. This safeguards against tampering.
<b>Relieving function</b>	non-relieving
<b>Temperature range</b>	0 °C to 60 °C / 32 °F to 140 °F
<b>Material</b>	Body: zinc Elastomer: NBR/Buna-N

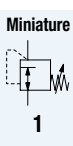
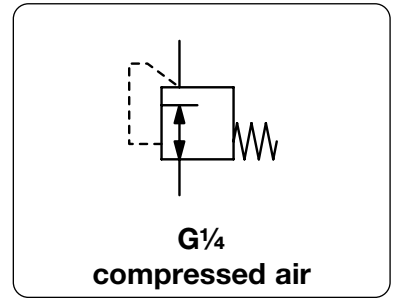

Dimensions			Flow rate	Supply pressure	Connection thread	Outlet pressure	Order number
Ø A	B	A/F	l/min*1	max. bar	G	bar*2	

Regulator for air „SaveAir®“				P: max. 18 bar, non-relieving, accuracy *2, made of zinc		231	
34	52	17	400	18	G1/4	1	231A0210
			600			2	231A0220
			700			3	231A0230
			700			4	231A0240
			700			5	231A0250
			800			6	231A0260
			800			7	231A0270
			800			8	231A0280



231

## Special options, add the appropriate letter

<b>NPT</b>	connection thread	231A 12 . .
<b>deviant pressure range</b>	indicate on order	231A . 2XX

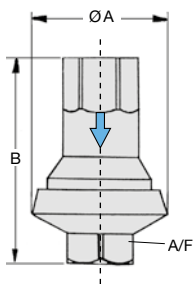

231

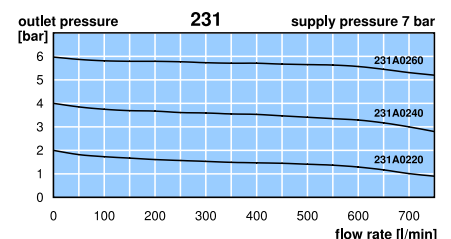
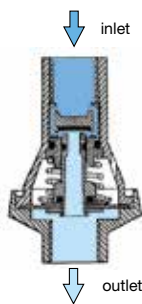

\*1  $P_s = 12 \text{ bar}$ ;  $\Delta p = 0.5 \text{ bar}$

\*2 Tolerance:  $< 4 \text{ bar} \pm 0.3 \text{ bar}$  (air,  $P_s = 6 \text{ bar}$ , 10 NI/min)  
 $\geq 4 \text{ bar} \pm 10\%$  (air,  $P_s = 10 \text{ bar}$ , 10 NI/min)



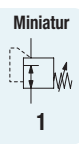

**Description** In-Line pressure regulator with factory-set outlet pressure, reducing from e.g. 15 bar to 6 bar. With an outlet pressure tolerance of only  $\pm 10\%$  <sup>2</sup> it is especially suitable for nailing machines.

**Benefits**

- Higher safety through lower pressure. Tools and equipment protected against pressure damages.
- Cost reduction through substantially reduced air consumption. Longer service life.
- Noise reduction for tools.

**Media** compressed air or non-corrosive gases

**Supply pressure** max. 25 bar

**Adjustment** Select the pressure regulator according to the desired outlet pressure. The outlet pressure cannot be subsequently adjusted. This safeguards against tampering.

**Relieving function** relieving at removal of supply pressure

**Temperature range** 0 °C to 80 °C / 32 °F to 176 °F

**Material** Body: aluminium  
Elastomer: NBR/Buna-N

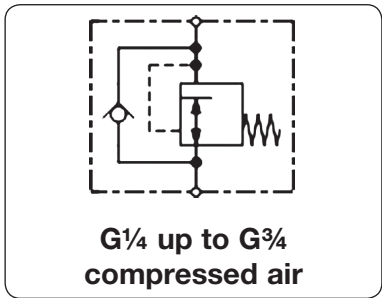

Dimensions				Flow rate	Supply pressure	Connection thread	Outlet pressure	Order number
Ø A	B	A/F 1	A/F 2					
mm	mm	mm	mm	l/min*1	max. bar	G	bar*2	

Regulator with relieving function				P <sub>i</sub> : max. 25 bar, accuracy*2, aluminium		232		
19	69	16	19	500	25	G <sup>1</sup> / <sub>4</sub> ia	2	232F0220
							3	232F0230
							4	232F0240
							5	232F0250
							6	232F0260
							7	232F0270
							8	232F0280
							19	59
3	232A0230							
4	232A0240							
5	232A0250							
6	232A0260							
7	232A0270							
8	232A0280							
25	63	22	25	1400	25	G <sup>3</sup> / <sub>8</sub>		
							3	232A0330
							4	232A0340
							5	232A0350
							6	232A0360
							7	232A0370
							8	232A0380
							30	68
3	232A0430							
4	232A0440							
5	232A0450							
6	232A0460							
7	232A0470							
8	232A0480							
40	102	34	40	2500	25	G <sup>3</sup> / <sub>4</sub>		
							4	232A0540
							6	232A0560
							8	232A0580



## Special options, add the appropriate letter

**NPT** connection thread 232. 1 . . .

**deviant pressure range** indicate on order 232. . . X X

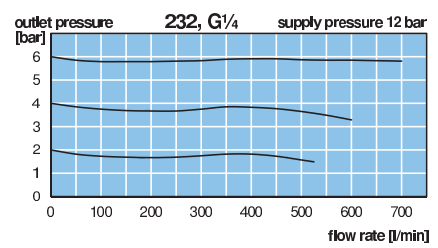
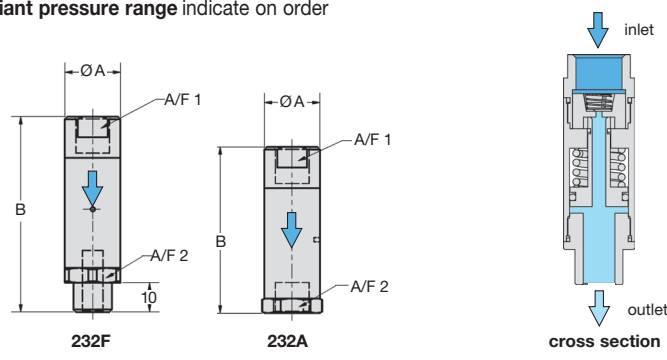

\*1 P<sub>e</sub> = 12 bar; Δp = 0.5 bar

\*2 Tolerance: < 4 bar ± 0.3 bar (air, P<sub>e</sub> = 6 bar, 10 NI/min)  
≥ 4 bar ± 10% (air, P<sub>e</sub> = 10 bar, 10 NI/min)

# MICRO PRESSURE REGULATOR

RR-M5

<b>Description</b>	Highly compact piston-operated regulator, suitable for panel mounting and basic pressure regulation.
<b>Media</b>	compressed air, non-corrosive gases or liquids
<b>Supply pressure</b>	max. 6 bar at 0.2 ... 2 bar pressure range, max. 10 bar at 1 ... 8 bar pressure range
<b>Adjustment</b>	by knurled-head screw with locknut
<b>Relieving function</b>	relieving for air, non-relieving for water
<b>Gauge port</b>	not available
<b>Mounting position</b>	any
<b>Temperature range</b>	0 °C to 60 °C / 32 °F to 140 °F, for appropriately conditioned compressed air down to -30 °C / -22 °F
<b>Material</b>	Body: nickel-plated brass Elastomer: NBR/Buna-N Inner valve: stainless steel and brass

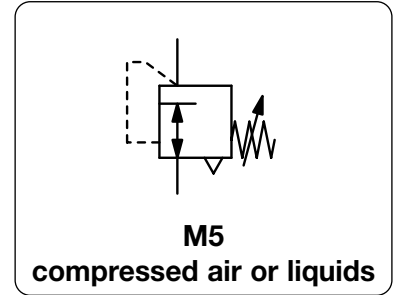

Dimensions			Flow rate	Supply pressure	Connection thread	Pressure range	Order number
A	B	A/F	l/min*1	max. bar	M5	bar	

Pressure regulator for air				supply pressure max. 6 / 10 bar, relieving	RR-M5
19	40	17	70	6	RR-M5A
17	40	17	70	10	RR-M5C



RR-M5

Pressure regulator for water				supply pressure max. 6 / 10 bar, non-relieving	RR-M5
19	40	17	1.2	6	RR-M5AK
17	40	17	1.2	10	RR-M5CK



RR-M5

## Special options, add the appropriate letter

for oxygen specially cleaned, with oxygen grease minimum purchase 50 pieces RR-M5 . . K15

## Accessories, enclosed

plastic panel nut M12x1K

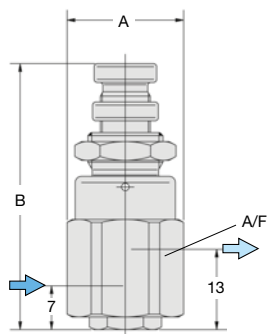
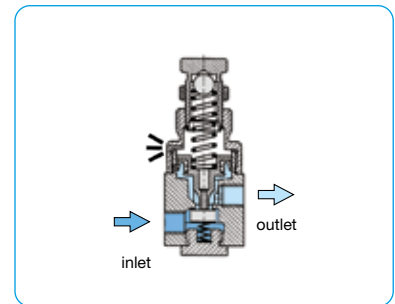

RR-M5

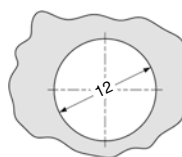

panel cut-out

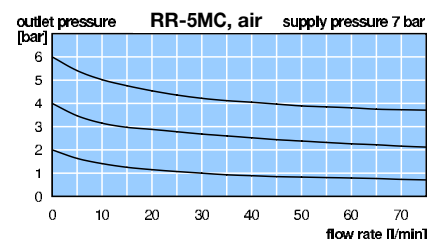

\*1 for compressed air: 7 bar supply pressure and 6 bar outlet pressure and 2 bar pressure drop  
for water: supply pressure 2 bar above outlet pressure

# MICRO PRESSURE REGULATOR

MAR

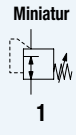

<b>Description</b>	Piston-operated compact pressure regulator with special seals for applications in the chemical and medical industry. Mounting nut included.
<b>Media</b>	compressed air, non-corrosive gases or liquids
<b>Supply pressure</b>	max. 21 bar
<b>Adjustment</b>	by knurled-head screw
<b>Relieving function</b>	relieving or non-relieving
<b>Gauge port</b>	not available
<b>Mounting position</b>	any
<b>Temperature range</b>	0 °C to 80 °C / 32 °F to 176 °F for NBR/Buna-N 0 °C to 110 °C / 32 °F to 230 °F for EPDM for appropriately conditioned compressed air down to -30°C / -22°F
<b>Material</b>	Body: brass Elastomer: NBR/Buna-N, optionally FKM or EPDM Inner valve: stainless steel and brass

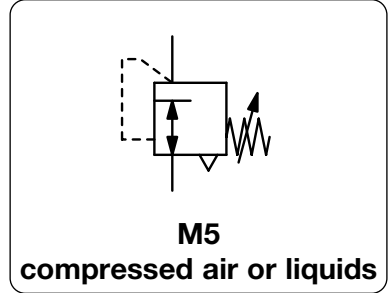

Dimensions			Description	Flow rate l/min*1	Connection thread		Pressure range bar	Order number
A	B	A/F			Inlet	Outlet		

Regulator with male thread				supply pressure max. 21 bar				MAR-1P
18	71	9.5	relieving	120	1/8" NPTa	10-32"	0.2 ... 1.4	MAR-1P-20
							0.2 ... 3.5	MAR-1P-50
							0.2 ... 7.0	MAR-1P
18	71	9.5	non-relieving	120	1/8" NPTa	M5	0.2 ... 1.4	MAR-1PNR-20
							0.2 ... 3.5	MAR-1PNR-50
							0.2 ... 7.0	MAR-1PNR



MAR-1P, with male thread

Regulator with female thread				supply pressure max. 21 bar				MAR-1
18	65	9.5	relieving	120	M5	M5	0.2 ... 1.4	MAR-1-20
							0.2 ... 3.5	MAR-1-50
							0.2 ... 7.0	MAR-1
18	65	9.5	non-relieving	120	M5	M5	0.2 ... 1.4	MAR-1NR-20
							0.2 ... 3.5	MAR-1NR-50
							0.2 ... 7.0	MAR-1NR



MAR-1, with female thread

**Special options,** add the appropriate letter

for oxygen	specialy cleaned, with oxygen grease	MAR- . NR- . . 15
FKM elastomer		MAR- . . . . V
EPDM elastomer		MAR- . . . . E
chemically nickel-plated	throughout	MAR- . . . . X13

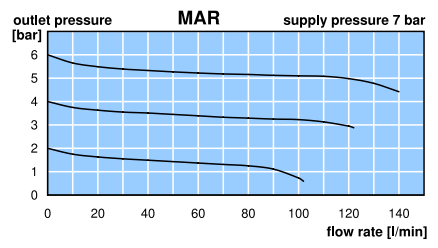
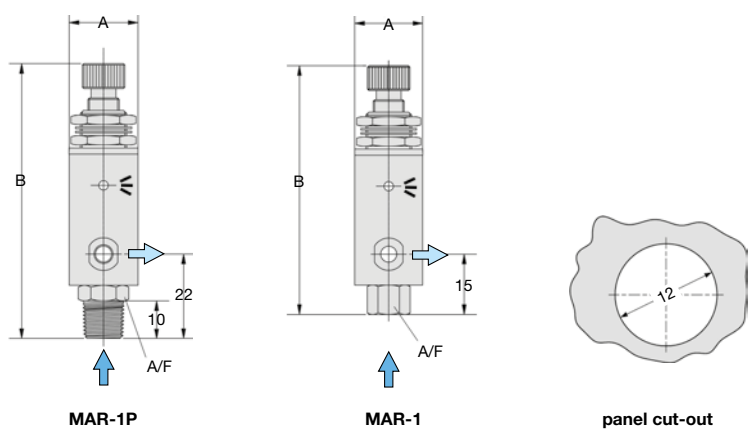

\*1 at 7 bar supply pressure, 6 bar outlet pressure and 1 bar pressure drop

PDF CAD  
www.aircom.net

Order example:  
MAR-1P-20



# PLASTIC MINIATURE PRECISION PRESSURE REGULATOR

## R800 / R900

<b>Description</b>	Miniature precision regulator with high supply sensitivity, small dimension, light weight. Hysteresis-free adjustment up to 20 turns. compressed air or non-corrosive gases	
<b>Media</b>	compressed air or non-corrosive gases	
<b>Supply pressure</b>	max. 10 bar	
<b>Accuracy</b>	<b>R800 / R900 / R901</b>	<b>R810 / R910 / R911</b>
	at supply pressure variation of 1 bar:	< 7 mbar pressure deviation
	at supply pressure removal/reapplication:	< 7 mbar pressure deviation
	setting accuracy:	< 2.5 mbar
<b>Air consumption</b>	0.35 l/min at 7 bar supply	0 l/min, flow > 20 ml/min recommended
<b>Relieving function</b>	relieving, optionally non-relieving	
<b>Relief capacity</b>	15 l/min at 0.35 bar outlet above set-point	<b>Gauge port</b> not available
<b>Temperature range</b>	4 °C to 66 °C / 40 °F to 150 °F	
<b>Material</b>	Body: polysulfones Elastomer: NBR/Buna-N Inner valve: stainless steel and acetal	

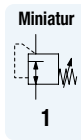
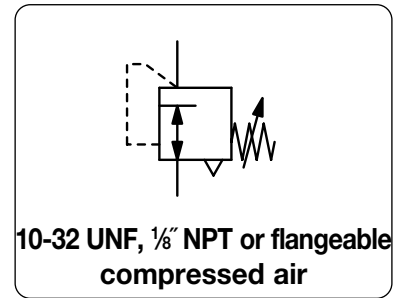

Dimensions			Pressure adjustment	Flow rate	Pressure range	Order number for manifold with o-ring	Order number 10-32 UNF standard
A	B	C	by	l/min*1	bar		

Precision pressure regulator						supply pressure max. 10 bar, relieving, with constant bleed	R900
29	78	8	knob	65	0.03 ... 0.24	<b>R900-3,5MWK</b>	<b>R900-3,5WK</b>
					0.03 ... 0.7	<b>R900- 10MWK</b>	<b>R900- 10WK</b>
					0.03 ... 2.1	<b>R900- 30MWK</b>	<b>R900- 30WK</b>
					0.03 ... 4.2	<b>R900- 60MWK</b>	<b>R900- 60WK</b>
					0.03 ... 6.2	<b>R900- 90MWK</b>	<b>R900- 90WK</b>
29	60	8	spindle	65	0.03 ... 0.24	<b>R900-3,5WOS</b>	<b>R900-3,5WOS</b>
					0.03 ... 0.7	<b>R900- 10WOS</b>	<b>R900- 10WOS</b>
					0.03 ... 2.1	<b>R900- 30WOS</b>	<b>R900- 30WOS</b>
					0.03 ... 4.2	<b>R900- 60WOS</b>	<b>R900- 60WOS</b>
					0.03 ... 6.2	<b>R900- 90WOS</b>	<b>R900- 90WOS</b>
29	43	8	preset	65	to be indicated	<b>R901- .. M</b>	<b>R901- ..</b>



R800-..WK mounting nut incl. R900-..WK mounting nut incl.



R910-..WOS mounting nut incl.



R901-.. R900-..MWOS mounting nut incl.

### Special options, add the appropriate letter

1/8" NPT	connection thread, width 40 mm	R8...W...
non-relieving	without constant bleed	R.1-.....
for oxygen	specially cleaned	R.....15

### Accessories, enclosed

mounting bracket made of steel for R800 and R900 **BW15-01**

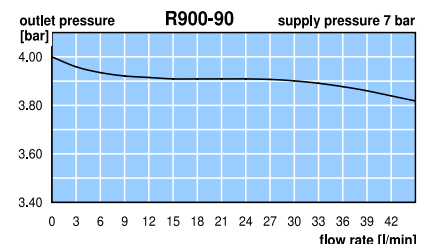
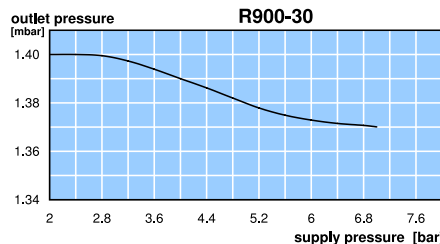
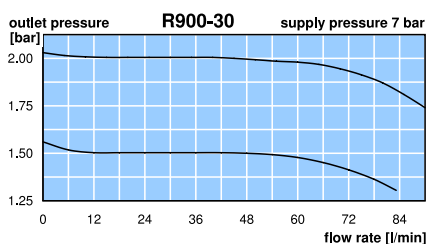
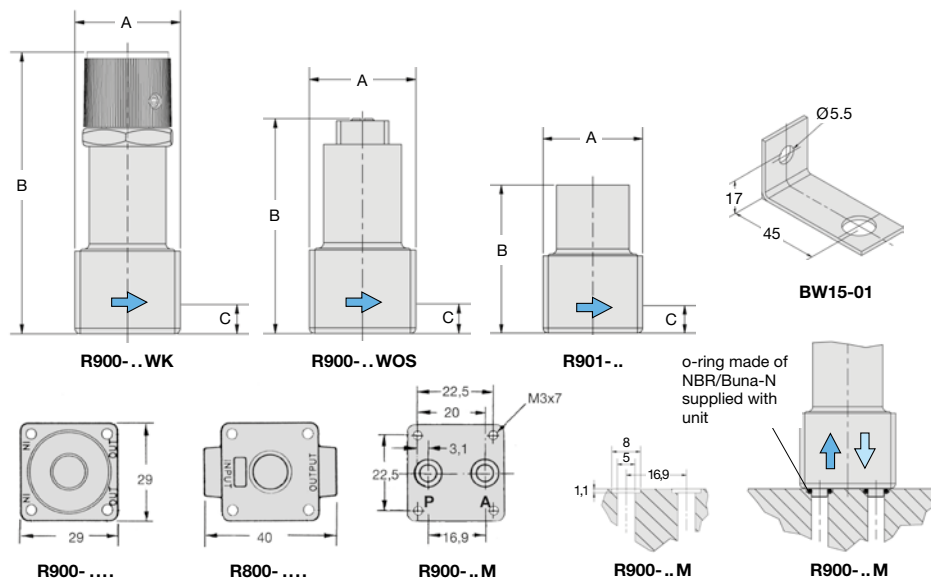

\*1 at 7 bar supply pressure and max. outlet pressure

PDF CAD  
www.aircom.net

Order example:  
**R900-3,5MWK**

# MINIATURE PRECISION PRESSURE REGULATOR

RT



<b>Description</b>	Compact, high-precision, diaphragm-operated pressure regulator for panel-mounting.	
<b>Media</b>	non-corrosive gases, filtered, lubricated or unlubricated compressed air	
<b>Supply pressure</b>	max. 17 bar	
<b>Air consumption</b>	ca 1.5 l/min at 7 bar supply pressure	
<b>Adjustment</b>	by handwheel with locknut	
<b>Relieving function</b>	relieving	
<b>Gauge port</b>	RT-M5: gauge port M5	RT-MF: not available
<b>Mounting position:</b>	any	
<b>Temperature range</b>	0 °C to 70 °C / 32 °F to 158 °F, for appropriately conditioned compressed air down to -30 °C / -22 °F	
<b>Material</b>	Body: anodized aluminium Elastomer: FKM Inner valve: stainless steel and brass	

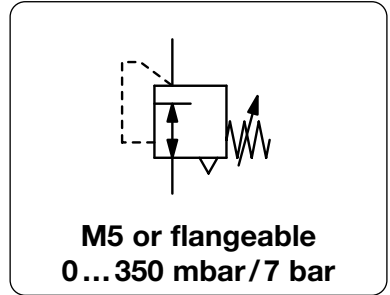

Dimensions			Flow rate	Supply pressure	Connection	Pressure range	Order number
A	B	C	l/min*1	max. bar	thread	bar	
mm	mm	mm			M5 / Flansch		

Pressure regulator M5				supply pressure max. 17 bar, with constant bleed		RT
25	83	14.5	100	17	M5	0...0.35 RT-M5A 0... 1.1 RT-M5B 0... 2.1 RT-M5C 0... 4.2 RT-M5D 0... 7.0 RT-M5E



RT-M5C  
with mounting nut

Regulator with flange				supply pressure max. 17 bar, with constant bleed		RT
25	83	-	100	17	flange	0...0.35 RT-MFA 0... 1.1 RT-MFB 0... 2.1 RT-MFC 0... 4.2 RT-MFD 0... 7.0 RT-MFE



RT-MFC  
with flange and mounting nut

Special options, add the appropriate letter		
side connection	M5 or o-ring	RT-M. .X14
1/16" NPT	ports with female threads	RT-M. .X61

Accessories, enclosed		
mounting bracket	made of steel, mounting nut at the device	BW10-01

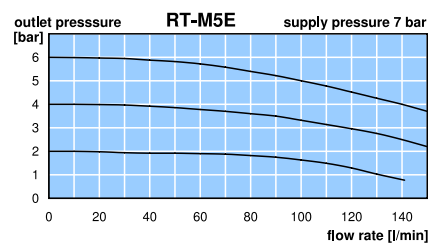
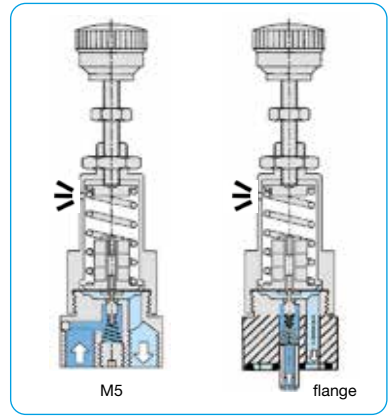
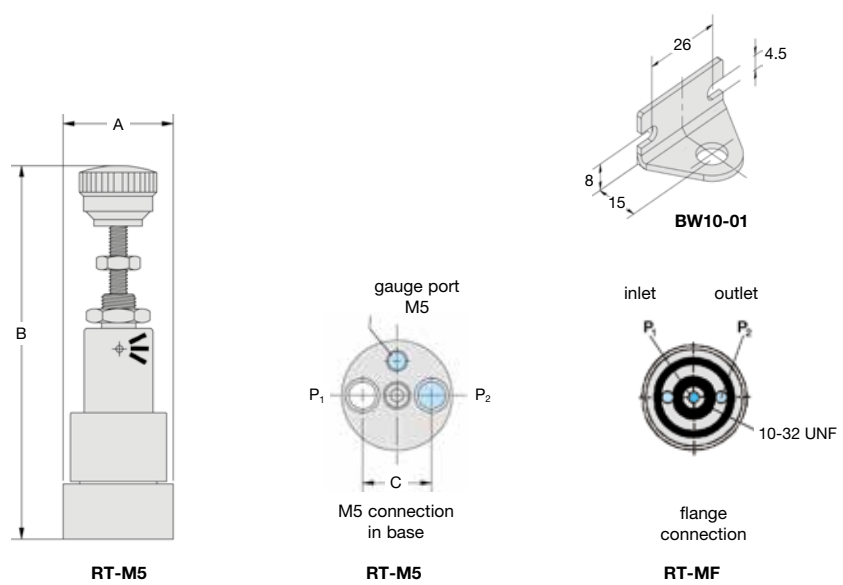

\*1 for compressed air: 7 bar supply pressure, 6 bar outlet pressure and 1 bar pressure drop

PDF CAD  
www.aircom.net

Order example:  
RT-M5A

# PRECISION PRESSURE REGULATOR MADE OF PLASTIC

**R039**

<b>Description</b>	Diaphragm miniature pressure regulator of small and lightweight design. The regulator has increased accuracy due to a rolling diaphragm and a piston compensated to inlet pressure.	
<b>Media</b>	compressed air, non-corrosive gases or liquids	
<b>Supply pressure</b>	max. 16 bar	
<b>Air consumption</b>	without constant bleed	R039-F with max. 3 l/min air consumption
<b>Adjustment</b>	by plastic knob with snap-lock	
<b>Relieving function</b>	relieving for compressed air,	red adjusting knob
	non-relieving for liquids,	black adjusting knob
<b>Gauge port</b>	G $\frac{1}{8}$ on both sides of the body, screw plugs supplied	
<b>Mounting position</b>	any	
<b>Temperature range</b>	0 °C to 50 °C / 32 °F to 122 °F for NBR/Buna-N	
<b>Material</b>	Body: POM with brass thread insert Elastomer: NBR/Buna-N Inner valve: brass	

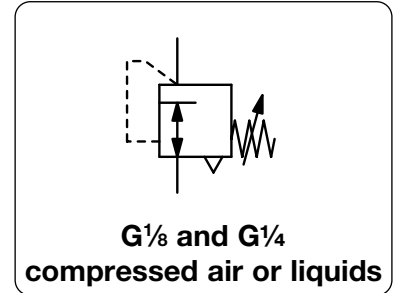

Dimensions			Flow rate		Connection	Pressure	Order number	Order number
A	B	C	water	air	thread	range	for water	for compressed air
mm	mm	mm	l/min*1	l/min*1	G	bar	non-relieving	relieving

Regulator w. increased accuracy							supply pressure max. 16 bar, w. rolling diaphragm, inlet pressure-compensated		<b>R039</b>
41	86	11	5	350	G $\frac{1}{8}$	0.1 ... 1	<b>R039-010K</b>	<b>R039-010</b>	<b>R039-010</b>
						0.2 ... 2	<b>R039-01AK</b>	<b>R039-01A</b>	<b>R039-01A</b>
						0.2 ... 4	<b>R039-01BK</b>	<b>R039-01B</b>	<b>R039-01B</b>
						0.3 ... 8	<b>R039-01CK</b>	<b>R039-01C</b>	<b>R039-01C</b>
						0.3 ... 12	<b>R039-01DK</b>	<b>R039-01D</b>	<b>R039-01D</b>
41	86	11	5	380	G $\frac{1}{4}$	0.1 ... 1	<b>R039-020K</b>	<b>R039-020</b>	<b>R039-020</b>
						0.2 ... 2	<b>R039-02AK</b>	<b>R039-02A</b>	<b>R039-02A</b>
						0.2 ... 4	<b>R039-02BK</b>	<b>R039-02B</b>	<b>R039-02B</b>
						0.3 ... 8	<b>R039-02CK</b>	<b>R039-02C</b>	<b>R039-02C</b>
						0.3 ... 12	<b>R039-02DK</b>	<b>R039-02D</b>	<b>R039-02D</b>



Precision pressure regulator							3 l/min air consumption, P <sub>i</sub> : max. 16 bar, w. rolling diaphragm, inlet pressure-compensated		<b>R039-F</b>
41	86	11	5	350	G $\frac{1}{8}$	0.1 ... 1	<b>R039-010F</b>	<b>R039-010F</b>	<b>R039-010F</b>
						0.2 ... 2	<b>R039-01AF</b>	<b>R039-01AF</b>	<b>R039-01AF</b>
						0.2 ... 4	<b>R039-01BF</b>	<b>R039-01BF</b>	<b>R039-01BF</b>
						0.3 ... 8	<b>R039-01CF</b>	<b>R039-01CF</b>	<b>R039-01CF</b>
						0.3 ... 12	<b>R039-01DF</b>	<b>R039-01DF</b>	<b>R039-01DF</b>
41	86	11	5	380	G $\frac{1}{4}$	0.1 ... 1	<b>R039-020F</b>	<b>R039-020F</b>	<b>R039-020F</b>
						0.2 ... 2	<b>R039-02AF</b>	<b>R039-02AF</b>	<b>R039-02AF</b>
						0.2 ... 4	<b>R039-02BF</b>	<b>R039-02BF</b>	<b>R039-02BF</b>
						0.3 ... 8	<b>R039-02CF</b>	<b>R039-02CF</b>	<b>R039-02CF</b>
						0.3 ... 12	<b>R039-02DF</b>	<b>R039-02DF</b>	<b>R039-02DF</b>



Special options, add the appropriate letter			
<b>adjustment lock</b>	non-adjustable knob		<b>R039-0 . . T</b>
<b>without gauge port</b>			<b>R039-0 . . X02</b>
<b>for oxygen</b>	especially cleaned, with oxygen grease	not for R039-0..F	<b>R039-0 . . K15</b>

Accessories, enclosed			
<b>pressure gauge</b>	Ø 40 mm, 0...*2 bar, G $\frac{1}{8}$	<b>MA4001- . . *2</b>	
<b>mounting bracket</b>	made of steel	<b>BW30-02</b>	
<b>mounting nut</b>	made of plastic	<b>M30x1,5K</b>	
	made of aluminium	<b>M30x1,5A</b>	

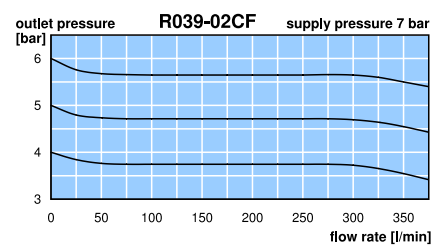
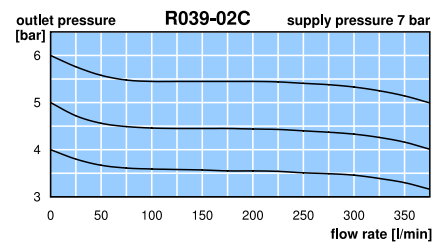
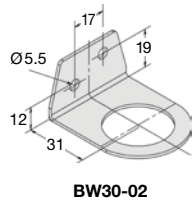
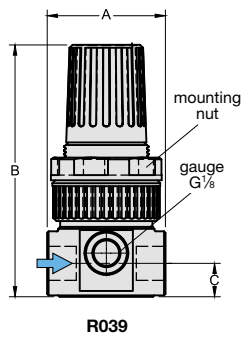

\*1 at 7 bar supply pressure, 6 bar outlet pressure and 1 bar pressure drop, for water: supply pressure 2 bar above outlet pressure  
\*2 02 = 0...2.5 bar, 04 = 0...4 bar, 10 = 0...10 bar, 16 = 0...16 bar

# MODULAR MINIATURE PRESSURE REGULATOR „AIRLOGIC“

# R6 / RP / M5000

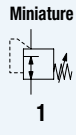

### Description

**Pressure regulator R6** Design as R7 but for bottom-sided flange assembly via fittings and o-rings made of NBR/Buna-N. Mounting through four screws (M3) with extremely small screw heads.

**Pressure regulator RP** This model guards against unauthorised tampering of pressure. Alternatively available with preset pressure. The pressure is to be set between 30 mbar and 2.8 bar. Its headroom is reduced to 49 mm.

**Diverter block M5000** M3000 features four ports sideways and one on top. All ports can be provided with threads or blank slides, the ports sideways optionally with connector slides.

**Top cover**

**Connector slide**

**Assembly** After loosening the bottom screw any placements of threads, connector and blank slides are possible. Sealing results from o-rings made of NBR/Buna-N.

**Temperature range** 4 °C to 70 °C / 39.2 °F to 158 °F

**Material** Body: glass fiber-reinforced Celcon Inner valve: stainless steel and Celcon  
Elastomer: NBR/Buna-N

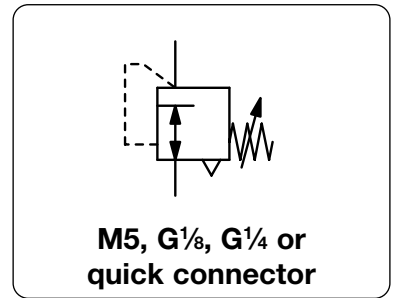

Dimensions			Flow rate l/min*1	Supply pressure max. bar	Connection thread G/ flange	Pressure range bar	Order number
A	B	C					
mm	mm	mm					

Precision regulator with flange					with adjusting knob, relieving, gauge port G $\frac{1}{8}$ on one side	R6
47	92	-	140	10	flange	R6-010-B1BB R6-030-B1BB R6-060-B1BB R6-100-B1BB



R6

Regulator with adjustment lock					adjustment with socket wrench, relieving, gauge port G $\frac{1}{8}$ on one side	RP
47	49	14	140	10	G $\frac{1}{8}$	RP7-040-111B RP6-040-B1BB
32	49	-			flange	



RP7 for socket wrench

RP6 with flange

Diverter block G $\frac{1}{8}$				e.g. all ports G $\frac{1}{8}$	M5000
47	42	14	without filter	-	G $\frac{1}{8}$
			with filter, 380 $\mu$ m		connection
					M5000-11111 M5001-11111

## Special options and accessories

see adjoining page

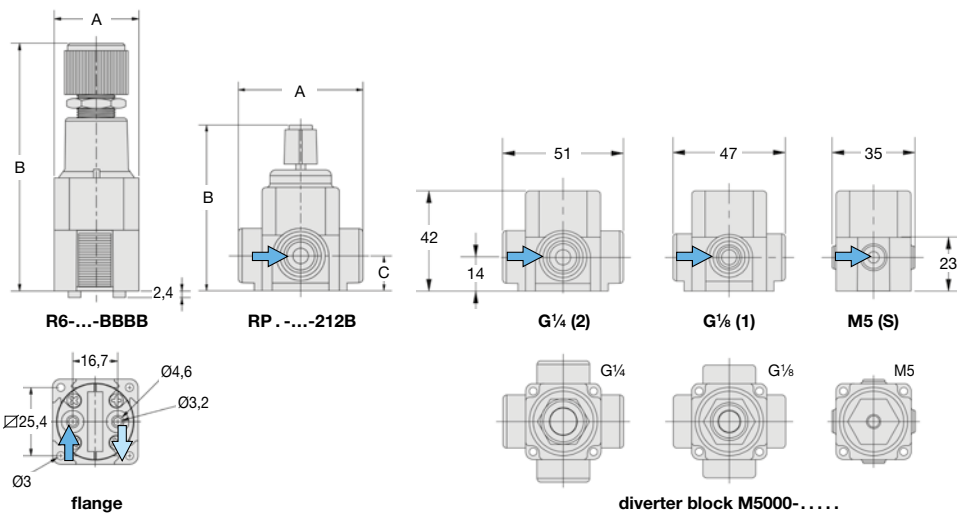

M5000-SBSBS

M5000-1S1SB



M5000-11111, G $\frac{1}{8}$

M5000-22222, G $\frac{1}{4}$

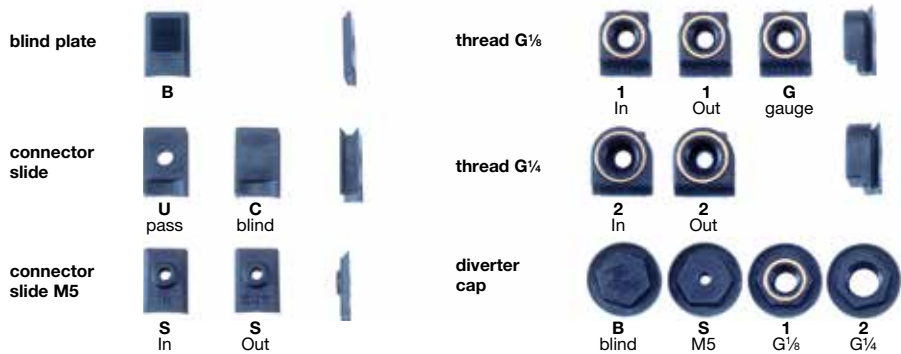

\*1 at 7 bar supply pressure, 6 bar outlet pressure and 1 bar pressure drop

\*2 indicate preset pressure on order

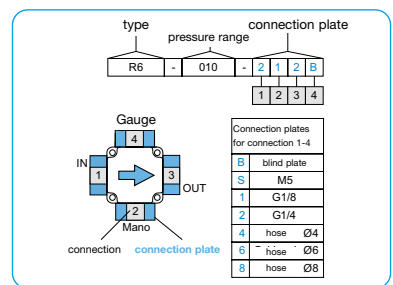

connector slides configuration

PDF CAD  
www.aircom.net



Order example:  
R6-010-B1BB

<b>Description</b>	Miniature pressure regulator with unique modular dovetail design allowing its individual use or assembly into a modular combination of pneumatic components through connector slides.	
<b>Identification marking</b>	The item no. includes a four-digit number starting with the input port and continuing counterclockwise. The digit corresponds with the type of connector slide, e.g. 1 for G $\frac{1}{8}$ , 2 for G $\frac{1}{4}$ or B for blank.	
<b>Pressure regulator R7</b>	Designed for precise regulation of pressure. The regulator possesses a 20 turn adjustment range and excellent repeatability. The valve seat is protected by a filter/strainer at the input port.	
<b>Media</b>	5 $\mu$ m filtered compressed air and non-corrosive gases	<b>Supply pressure</b> max. 10 bar
<b>Accuracy</b>	at supply pressure variation of 1 bar: at supply pressure removal/reapplication: at variations in temperature of 25 °C / K:	< 10 mbar pressure deviation < 10 mbar pressure deviation < 10 mbar pressure deviation
<b>Air consumption</b>	0.3 l/min at 7 bar supply pressure	<b>Adjustment</b> by knob
<b>Relieving function</b>	relieving	<b>Mounting position</b> any
<b>Gauge port</b>	G $\frac{1}{8}$ via threaded slide	

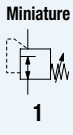
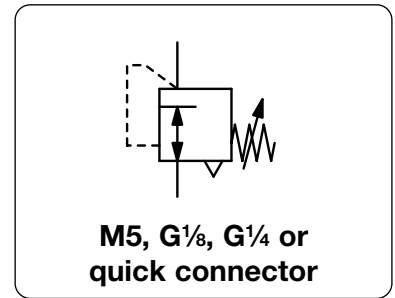

Dimensions			Flow rate l/min*1	Supply pressure max. bar	Connection thread G	Pressure rang bar	Order number
A	B	C					

Precision regulator				with adjusting knob, relieving, gauge port G $\frac{1}{8}$ on one side		R7	
47	92	14	140	10	G $\frac{1}{8}$	0.01...0.7 0.02...2.1 0.03...4.1 0.03...7.0	R7-010-111B R7-030-111B R7-060-111B R7-100-111B
51	92	14	140	10	G $\frac{1}{4}$	0.01...0.7 0.02...2.1 0.03...4.1 0.03...7.0	R7-010-212B R7-030-212B R7-060-212B R7-100-212B



### Special options, add the appropriate letter or number

<b>with spindle</b>	screwdriver adjustment, height 77 mm	R.-...-...S
<b>thread</b>	M5 connection thread	R.-...-S...
	G $\frac{1}{8}$	R.-...-1...
	G $\frac{1}{4}$	R.-...-2...
<b>quick connector</b>	external diameter of hose	R.-...-4...
	Ø 4	R.-...-6...
	Ø 6	R.-...-8...
	Ø 8	R.-...-B...
<b>breech plate</b>		R.-...-U...
<b>connection plate</b>	with permanent pressure supply	R.-...-C...
	without passage, modular combination of two devices	R.-...-W...
<b>wall mounting</b>	at breech plate	



### Accessories, enclosed

<b>pressure gauge</b>	Ø 23 mm, 0...*2 bar, G $\frac{1}{8}$	MA2301-...*2
-----------------------	--------------------------------------	--------------

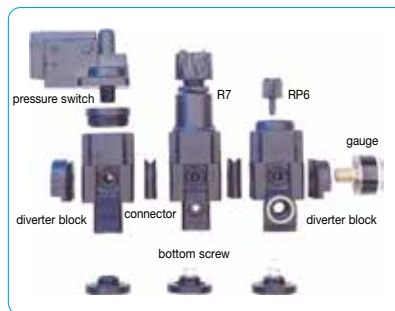
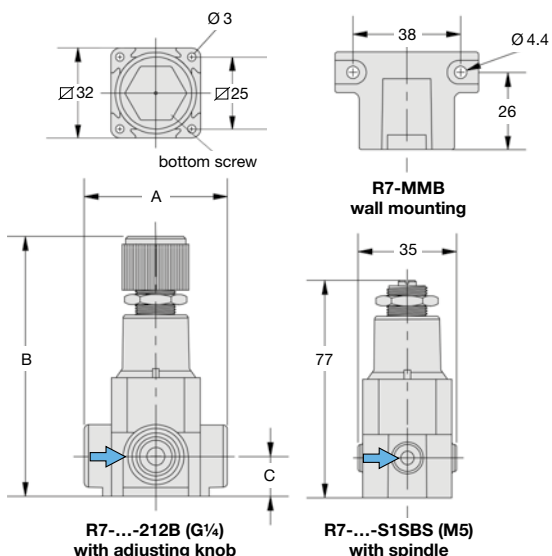

\*1 at 7 bar supply pressure, 6 bar outlet pressure and 1 bar pressure drop  
\*2 04 = 0...4 bar, 06 = 0...6 bar, 10 = 0...10 bar

# PRECISION REGULATOR WITH INLET PRESSURE COMPENSATION

## R342 / R344

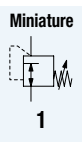

<b>Description</b>	Compact diaphragm regulator for quick regulating operations. Due to the pressure-compensated piston fluctuations on inlet pressure have only marginal effect on the outlet pressure's stability.
<b>Media</b>	compressed air or non-corrosive gases
<b>Supply pressure</b>	max. 17 bar
<b>Adjustment</b>	by plastic knob with snap-lock
<b>Relieving function</b>	relieving, optionally non-relieving
<b>Gauge port</b>	G $\frac{1}{8}$ on both sides of the body, screw plugs supplied. Without gauge port at regulator with flange.
<b>Mounting position</b>	any
<b>Temperature range</b>	0 °C to 70 °C / 32 °F to 158 °F, for appropriately conditioned compressed air down to -30 °C / -22 °F
<b>Material</b>	Body: aluminium Spring cage: glass fibre-reinforced plastic Elastomer: NBR/Buna-N Inner valve: steel, brass, plastic Valve seat: acetal

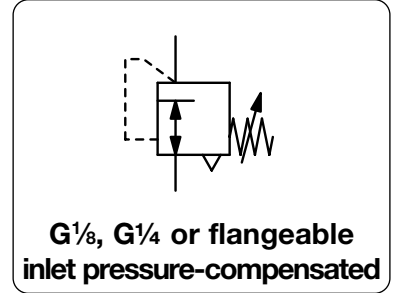

Dimensions			Flow rate l/min	Connection thread G / flange	Pressure range bar	Order number
A	B	C				

Regulator w. inlet pressure compensation						supply pressure max. 17 bar, relieving, without constant bleed	<b>R344</b>
40	83	14	500	G $\frac{1}{8}$	0.2...2		<b>R344-01A</b>
					0.2...4		<b>R344-01B</b>
					0.3...9		<b>R344-01C</b>
40	83	14	500	G $\frac{1}{4}$	0.2...2		<b>R344-02A</b>
					0.2...4		<b>R344-02B</b>
					0.3...9		<b>R344-02C</b>



R344

Regulator with flange						supply pressure max. 17 bar, relieving, without constant bleed, inlet pressure compensation	<b>R342</b>
38	83	13	500	flange	0.2...2		<b>R342-0MA</b>
					0.2...4		<b>R342-0MB</b>
					0.3...9		<b>R342-0MC</b>



R342, flangeable

### Special options, add the appropriate letter or number

<b>NPT</b>	connection thread	R344-0 . . N
<b>non-relieving</b>	without relieving function	R34.-0 . . K
<b>for oxygen</b>	specially cleaned, with oxygen grease	R34.-0 . . K15
<b>FKM elastomer</b>		R34.-0 . . X64

### Accessories, enclosed

<b>pressure gauge</b>	Ø 40 mm, 0... <sup>*2</sup> bar, G $\frac{1}{8}$	R344 only	<b>MA4001- . . <sup>*2</sup></b>
<b>mounting bracket</b>	made of steel	R344 only	<b>BW30-02</b>
<b>mounting nut</b>	made of plastic	R344 only	<b>M30x1,5K</b>
	made of aluminium	R344 only	<b>M30x1,5A</b>

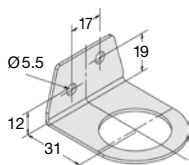

BW30-02

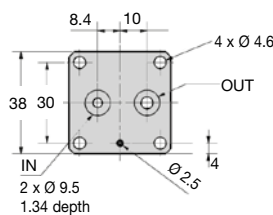

R342 bottom view

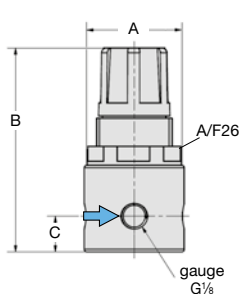

R344

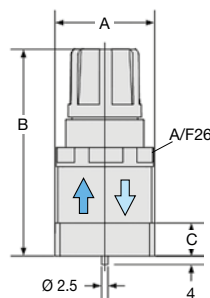

R342

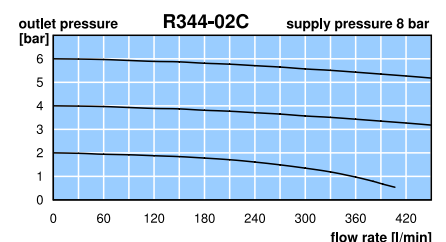

\*1 at 8 bar supply pressure, 6 bar outlet pressure and 1 bar pressure drop

\*2 02 = 0...2.5 bar, 04 = 0...4 bar, 10 = 0...10 bar

Gauges: see chapter for measuring devices

PDF CAD  
www.aircom.net



Order example:  
R344-01A

# MINIATURE PRESSURE REGULATOR

# R364 / R374

<b>Description</b>	Compact regulator with diaphragm.
<b>Media</b>	compressed air, non-corrosive gases or liquids
<b>Supply pressure</b>	max. 21 bar
<b>Adjustment</b>	by plastic knob with snap-lock
<b>Relieving function</b>	relieving, optionally non-relieving
<b>Gauge port</b>	G $\frac{1}{8}$ on both sides of the body, screw plugs supplied
<b>Mounting position</b>	any
<b>Temperature range</b>	0 °C to 50 °C / 32 °F to 122 °F, for appropriately conditioned compressed air down to -30 °C / -22 °F 0 °C to 80 °C / 32 °F to 176 °F, for spring cage made of brass
<b>Material</b>	Body: brass at R364, aluminium at R374 Spring cage: glass fibre reinforced plastic, optionally brass Elastomer: NBR/Buna-N, optionally FKM Inner valve: brass, optionally stainless steel

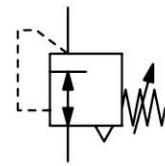

**G $\frac{1}{8}$  and G $\frac{1}{4}$   
compressed air or liquids**

Dimensions			Flow rate		Connection	Pressure	Order
A	B	C	m $^3$ /h*1	l/min*1	thread	range	number
mm	mm	mm			G	bar	

Brass pressure regulator					supply pressure max. 21 bar, relieving		<b>R364</b>
35	76	12	27	450	G $\frac{1}{8}$	0.1 ... 1.0	R364-010
						0.2 ... 1.8	R364-01A
						0.2 ... 4.0	R364-01B
						0.3 ... 9.0	R364-01C
						0.5 ... 11	R364-01D
35	76	12	27	450	G $\frac{1}{4}$	0.1 ... 1.0	R364-020
						0.2 ... 1.8	R364-02A
						0.2 ... 4.0	R364-02B
						0.3 ... 9.0	R364-02C
						0.5 ... 11	R364-02D



R364  
made of brass

Aluminium pressure regulator					supply pressure max. 21 bar, relieving		<b>R374</b>
35	76	12	27	450	G $\frac{1}{8}$	0.1 ... 1.0	R374-010
						0.2 ... 1.8	R374-01A
						0.2 ... 4.0	R374-01B
						0.3 ... 9.0	R374-01C
						0.5 ... 11	R374-01D
35	76	12	27	450	G $\frac{1}{4}$	0.1 ... 1.0	R374-020
						0.2 ... 1.8	R374-02A
						0.2 ... 4.0	R374-02B
						0.3 ... 9.0	R374-02C
						0.5 ... 11	R374-02D



R374  
made of aluminium

## Special options, add the appropriate letter

<b>NPT</b>	connection thread	R3. 4-0 . . N
<b>non-relieving</b>	without relieving function	R3. 4-0 . . K
<b>adjustment lock</b>	socket wrench adjustment, height 64 mm	R3. 4-0 . . T
<b>free of grease and oil</b>	especially cleaned, suitable for oxygen	R3. 4-0 . . L
<b>FKM elastomer</b>	inner parts made of brass	R3. 4-0 . . X64
	inner parts made of stainless steel	R3. 4-0 . . X08
<b>EPDM elastomer</b>	inner parts m. o. brass, PTFE-diaphragm, W270, KTW, DVGN approval	R364-01 . X37
<b>brass spring cage</b>	including brass adjusting screw, max. 80 °C / 176 °F	R3. 4-0 . . X82

## Accessories, enclosed

<b>pressure gauge</b>	Ø 40 mm, 0 ... *2 bar, G $\frac{1}{8}$	<b>MA4001- . . *2</b>
<b>mounting bracket</b>	made of steel	<b>BW30-02</b>
<b>mounting nut</b>	made of plastic	<b>M30x1,5K</b>
	made of aluminium	<b>M30x1,5A</b>



R364-02CT with adjustment lock      R364-02CX82 brass throughout

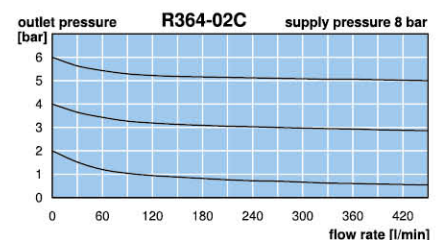
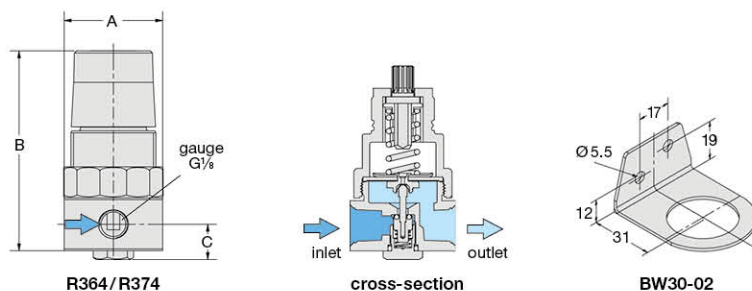

\*1 at 8 bar supply pressure, 6 bar outlet pressure and 1 bar pressure drop  
\*2 01 = 0...1 bar, 02 = 0...2,5 bar, 04 = 0...4 bar, 10 = 0...10 bar, 16 = 0...16 bar

Gauges: see chapter for measuring devices

PDF CAD  
www.aircom.net

Order example:  
R364-010

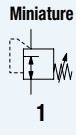

<b>Description</b>	R310: Diaphragm pressure regulator made of brass without constant bleed. R309: Precision pressure regulator with highly accurate inner valve and sensitive convoluted diaphragm. Of proven reliability and durability and designed for precise pressure regulation in the event of disturbances in flow, supply pressure or temperature. With very high capacity relief valve.	
<b>Media</b>	compressed air, non-corrosive gases or liquids	
<b>Supply pressure</b>	max. 25 bar for R310, max. 14 bar for R309 and R310-15	
<b>Adjustment</b>	by plastic knob with snap-lock	
<b>Relieving function</b>	relieving, optionally non-relieving for R310	
<b>Gauge port</b>	R310: G $\frac{1}{8}$ on both sides of the body, one screw plug supplied	R309: not available
<b>Mounting position</b>	any	
<b>Temperature range</b>	0 °C to 60 °C / 32 °F to 140 °F for NBR / Buna-N 0 °C to 80 °C / 32 °F to 176 °F for FKM or EPDM for appropriately conditioned compressed air down to -30 °C / -22 °F	
<b>Material</b>	Body: brass Spring cage: POM	Elastomer: NBR/Buna-N, optionally FKM or EPDM, e.g. for brake fluid Inner valve: stainless steel and brass

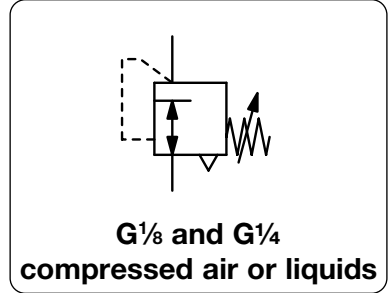

Dimensions			Flow rate l/min*1	Supply pressure max. bar	Connection thread G	Pressure range bar	Order number
A	B	C					

Pressure regulator							supply pressure max. 25 bar, relieving, gauge port G $\frac{1}{8}$ , inlet pressure-compensated	R310
40	80	16.5	220	25	G $\frac{1}{8}$	0.1... 3		R310-01B
						0.4... 10		R310-01D
						0.5... 16		R310-01E
40	80	16.5	220	25	G $\frac{1}{4}$	0.1... 3		R310-02B
						0.4... 10		R310-02D
						0.5... 16		R310-02E

Precision press. regulator							P1: max. 14 bar, relieving, inlet pressure-compensated without constant bleed, suitable for oxygen	R309
36	77	15	220	14	G $\frac{1}{8}$	0.1... 3		R309-01B
						0.4... 6		R309-01C



R310

### Special options, add the appropriate letter or number

<b>non-relieving</b>	without relieving function	R310-0...K
<b>for oxygen</b>	specially cleaned, P <sub>1</sub> : max. 14 bar, P <sub>2</sub> : max. 10 bar	R310-0...K15
<b>FKM elastomer</b>		R310-0...V
<b>EPDM elastomer</b>	non-relieving, e.g. for brake fluid	R310-0...KE

### Accessories, enclosed

<b>pressure gauge</b>	Ø 40 mm, 0...*2 bar, G $\frac{1}{8}$	R310 only	MA4001-...*2
<b>mounting bracket</b>	made of steel		BW30-02
<b>mounting nut</b>	made of plastic made of brass		M30x1,5K M30x1,5M



R309  
accessory: mounting nut

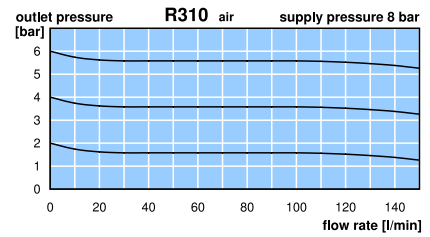
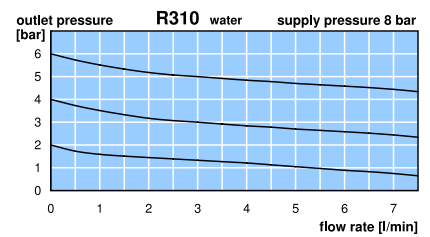
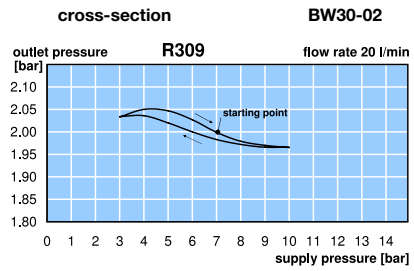
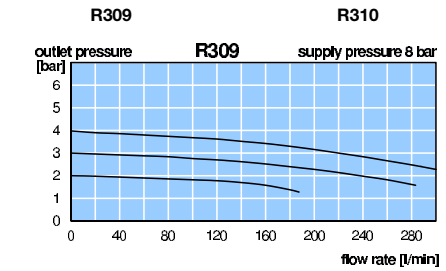
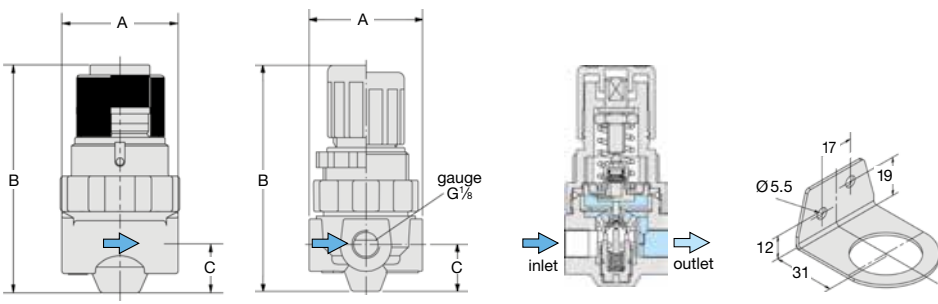

\*1 for compressed air: 8 bar supply pressure, 4 bar outlet pressure and 1 bar pressure drop  
\*2 01 = 0...1 bar, 04 = 0...4 bar, 10 = 0...10 bar, 16 = 0...16 bar



<b>Description</b>	Diaphragm miniature pressure regulator made of plastic and of small and lightweight design. All fluid-contact parts are approved by the FDA.
<b>Application area</b>	food industry and water circulation, e.g. for dialysis devices
<b>Media</b>	compressed air, non-corrosive gases, deionized water or other liquids
<b>Supply pressure</b>	max. 16 bar
<b>Adjustment</b>	by plastic knob with snap-lock
<b>Relieving function</b>	non-relieving
<b>Gauge port</b>	not available
<b>Mounting position</b>	any
<b>Temperature range</b>	0 °C to 50 °C / 32 °F to 122 °F
<b>Material</b>	Body: POM technopolymer with thread insert of SST 316, approved by FDA and WRAS Elastomer: EPDM with thread insert of SST 316, approved by FDA and KTW Valve and o-ring: Hytrel and EPDM, FDA-approved Grease: Klüber, UH184-201

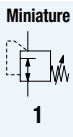
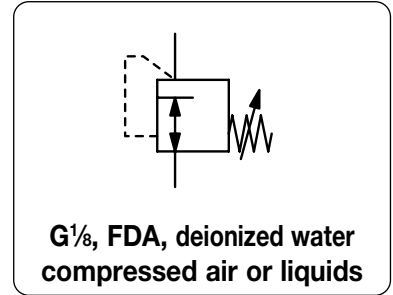

Dimensions			Flow rate		Connection	Pressure	Order
A	B	C	water	air	thread	range	number
mm	mm	mm	l/min*1	l/min	G	bar	

Pressure regulator w. FDA approval			supply pressure max. 16 bar, non-relieving EPDM, with inlet pressure compensation		Connection	Pressure range	Order number
41	86	11	5	350	G <sup>1</sup> / <sub>8</sub>	0.1 ... 1	<b>R037-010K</b>
						0.1 ... 2	<b>R037-01AK</b>
						0.2 ... 4	<b>R037-01BK</b>
						0.3 ... 8	<b>R037-01CK</b>
						0.4 ... 12	<b>R037-01DK</b>
41	86	11	5	380	G <sup>1</sup> / <sub>4</sub>	0,1 ... 1	<b>R037-020K</b>
						0,1 ... 2	<b>R037-02AK</b>
						0,2 ... 4	<b>R037-02BK</b>
						0,3 ... 8	<b>R037-02CK</b>
						0,4 ... 12	<b>R037-02DK</b>



R037

**Special options,** add the appropriate letter or number  
for oxygen                      specially cleaned, with oxygen grease                      R037-0 . . K15

**Accessories,** enclosed

mounting bracket	made of steel	<b>BW30-02</b>
mounting nut	made of plastic	<b>M30x1,5K</b>
	made of aluminium	<b>M30x1,5A</b>

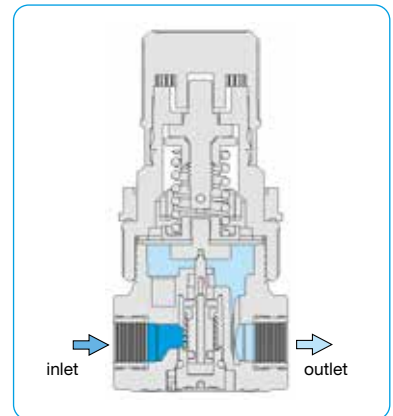

cross-section

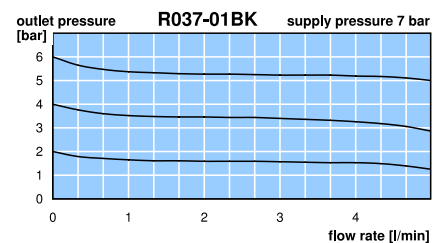
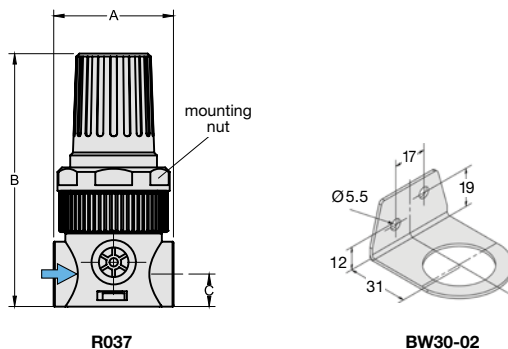

\*1 supply pressure 1 bar above outlet pressure

# MINIATURE PRECISION PRESSURE REGULATOR $\nabla$ 30 MM

R307



<b>Description</b>	Precision pressure regulator made of plastic, diaphragm-operated, with tamper-proof knob and without constant bleed. Excellent for portable systems thanks to small size and light weight of only 70 g. The regulator is suitable for oxygen and air.
<b>Media</b>	compressed air or non-corrosive gases
<b>Supply pressure</b>	max. 10 bar
<b>Adjustment</b>	by plastic knob with snap-lock
<b>Relieving function</b>	relieving, optionally non-relieving
<b>Gauge port</b>	G $\frac{1}{8}$ on both sides of the body, one screw plug supplied
<b>Mounting position</b>	any
<b>Temperature range</b>	0 °C to 60 °C / 32 °F to 140 °F
<b>Material</b>	Body: POM Elastomer: NBR/Buna-N Inner valve: brass

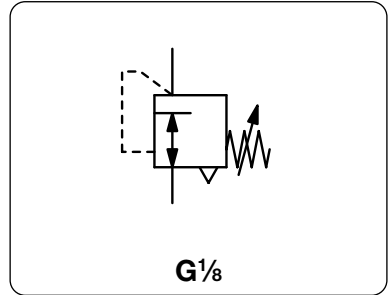

Dimensions			Flow rate	Supply pressure	Connection thread	Pressure range	Order number
A	B	C	l/min*1	max. bar	G	bar	
mm	mm	mm					

Miniature pressure regulator	supply pressure max. 10 bar, relieving, without constant bleed	R307					
30	64	8	360	10	G $\frac{1}{8}$	0.2 ... 2.5	R307-01B
						0.2 ... 3.5	R307-01C
						0.2 ... 8.0	R307-01D

**Special options, add the appropriate letter**

non-relieving	without relieving function	R307-01 . K
for oxygen	specially cleaned, with oxygen grease	R307-01 . K15



R307

**Accessories, enclosed**

pressure gauge	$\varnothing$ 23 mm, 0...*2 bar, G $\frac{1}{8}$	MA2301-...*2
mounting nut	made of brass	M24x1,5M

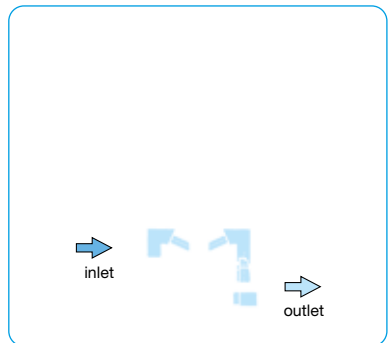

cross-section

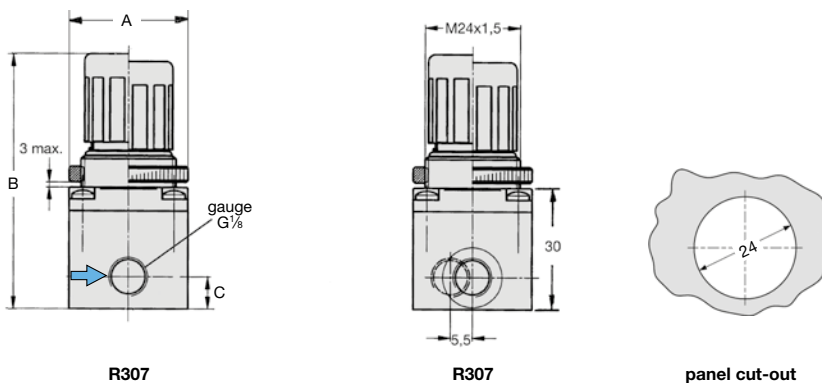

R307

R307

panel cut-out

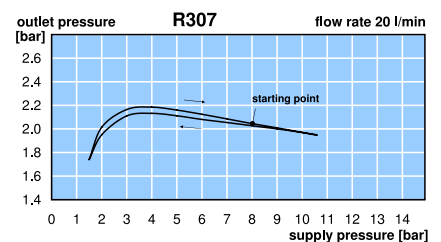
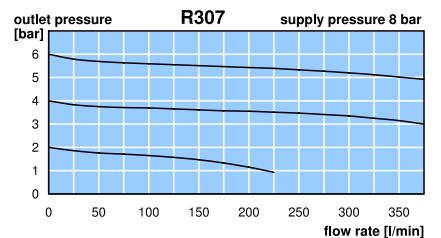

\*1 at 8 bar supply pressure, 6 bar outlet pressure and 1 bar pressure drop  
\*2 04 = 0...4 bar, 10 = 0...10 bar

Gauges: see chapter for measuring devices

PDF CAD  
www.aircom.net

Order example:  
R307-01B

# MINIATURE PRECISION PRESSURE REGULATOR $\nabla$ 30 MM, WITH FLANGE

R308

<b>Description</b>	Precision pressure regulator, made of plastic, diaphragm-operated, with tamper-proof knob and without constant bleed. Excellent for portable systems thanks to small size and light weight of only 70 g. The regulator is suitable for oxygen and air.
<b>Media</b>	compressed air or non-corrosive gases
<b>Supply pressure</b>	max. 10 bar
<b>Adjustment</b>	by plastic knob with snap-lock
<b>Relieving function</b>	relieving, optionally non-relieving
<b>Gauge port</b>	not available
<b>Mounting position</b>	any
<b>Temperature range</b>	0° C to 60 °C / 32 °F to 140 °F
<b>Material</b>	Body: POM Elastomer: NBR/Buna-N Inner valve: brass

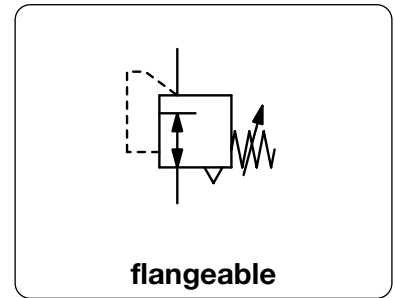

Dimensions		Flow rate	Supply pressure	Connection	Pressure range	Order number
A	B	l/min*1	max. bar	flange	bar	
mm	mm					

Precision regulator with flange	supply pressure max. 10 bar, relieving, without constant bleed	R308				
30	64	200	10	flange	0 ... 0.25	R308-P00
					0.2 ... 2.5	R308-P0B
					0.2 ... 3.5	R308-P0C
					0.2 ... 8.0	R308-P0D



R308, flangeable

## Special options, add the appropriate letter

<b>non-relieving</b>	without relieving function	R308-P0. K
<b>or oxygen</b>	specially cleaned, with oxygen grease	R308-P0. K15

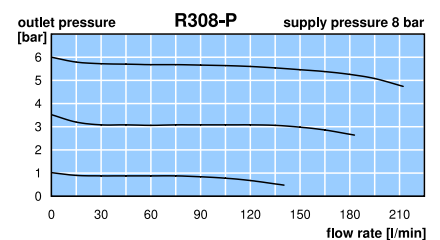
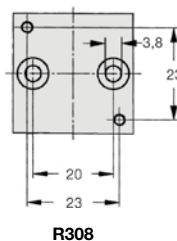
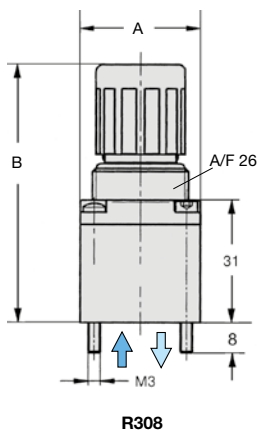
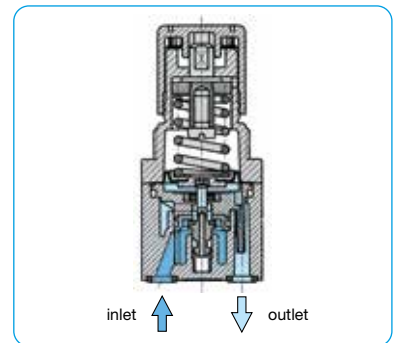

\*1 for compressed air: 8 bar supply pressure, 6 bar outlet pressure and 1 bar pressure drop

# CARTRIDGE PRESSURE REGULATOR

RC



<b>Description</b>	Piston-operated cartridge pressure regulator suitable for assembly block.
<b>Media</b>	compressed air filtered to 50 µm, lubricated or unlubricated
<b>Supply pressure</b>	max. 10 bar
<b>Adjustment</b>	by knurled-head screw with locknut
<b>Relieving function</b>	relieving
<b>Gauge port</b>	not available
<b>Mounting position</b>	any
<b>Temperature range</b>	0 °C to 60 °C / 32 °F to 140 °F, for appropriately conditioned compressed air down to -30 °C / -22 °F
<b>Material</b>	Body: nickel-plated brass Elastomer: NBR/Buna-N

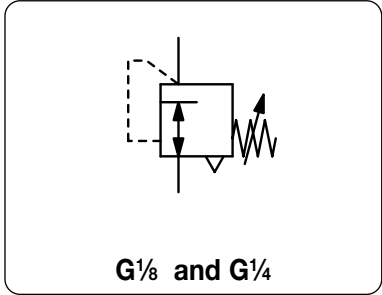

Dimensions				Flow rate	Supply pressure	Connection thread	Pressure range	Order number
A	B	C	A/F	l/min*1	max. bar	G	bar	

Cartridge regulator					supply pressure max. 10 bar, relieving, without constant bleed	RC
15	57	15	14	150	10	G <sup>1</sup> / <sub>8</sub> 1... 8 bar <b>RC-01C</b>
19	63	18	17	260	10	G <sup>1</sup> / <sub>4</sub> 1... 8 bar <b>RC-02C</b>



Step drill for cartridge seat				RCS
16	-	-	-	G <sup>1</sup> / <sub>8</sub> <b>RCS-01</b>
20	-	-	-	G <sup>1</sup> / <sub>4</sub> <b>RCS-02</b>

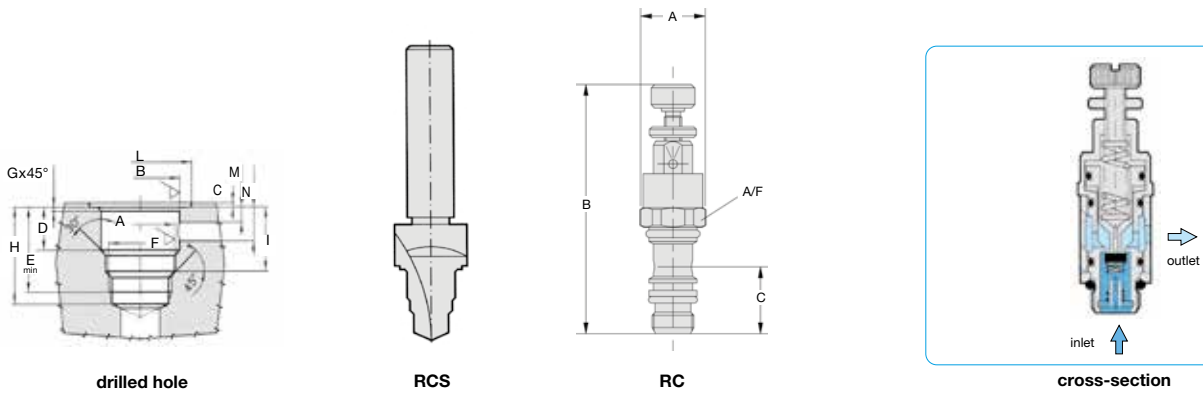

drill	F	A	B	C	D
<b>RCS-01</b>	1/8	9.8 - 0.1/-0	11.2 ± 0.05	0.5 ± 0.5	15.6 ± 0.07
<b>RCS-02</b>	1/4	13.5 + 0.1/-0	14.4 ± 0.05	0.5 ± 0.5	17.5 ± 0.07

drill	E	G	H	I	L	M	N
<b>RCS-01</b>	24.6	0.3	27	18.1 ± 0.2	15.4	3.5	12
<b>RCS-02</b>	28	0.4	31.2	20.8 ± 0.2	19.4	3.5	13.5

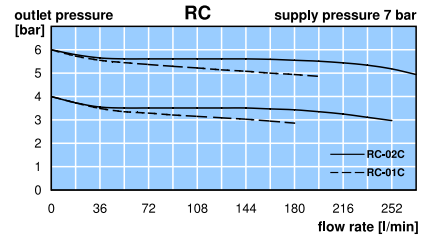

\*1 at 7 bar supply pressure, 6 bar outlet pressure and 1 bar pressure drop